

# Universal Pipette Tips Dimension

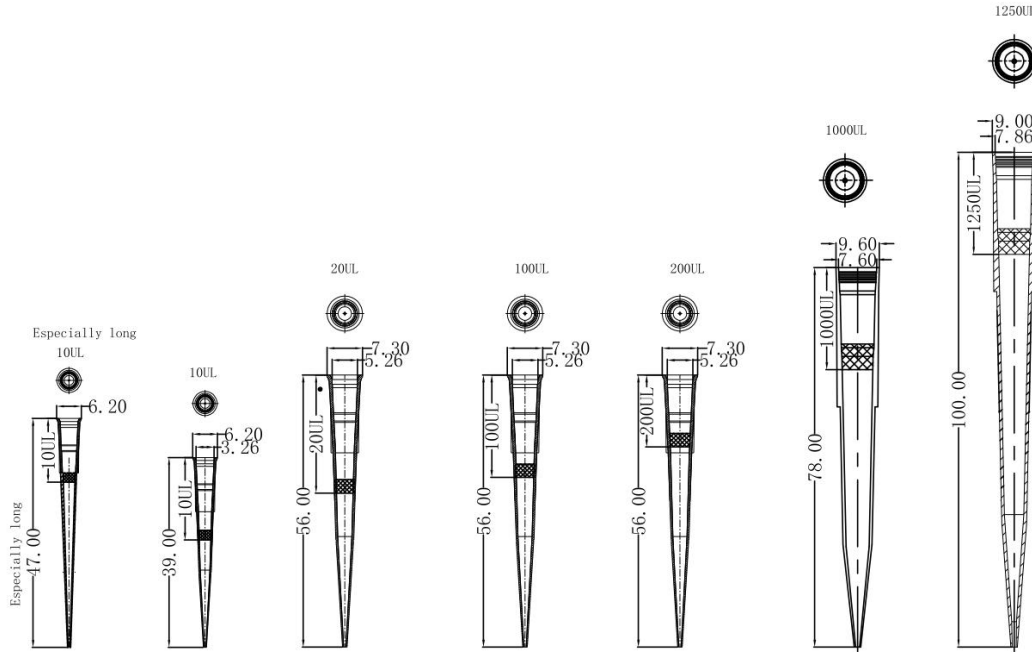

## Pipette tips Volume Filter/Non filter

- 10ul -39mm Pipette tips Filter/Non filter
- 10ul -47mm XL Pipette tips Filter/Non filter
- 20ul -56mm Pipette tips Filter /Non filter
- 100ul -56mm Pipette tips Filter /Non filter
- 200ul -56mm Pipette tips Filter /Non filter
- 1000ul -78mm Pipette tips Filter /Non filter
- 1250ul -100mm Pipette tips Filter/Non filter

### STERILE FILTER TIPS, RACKED, IN FILP LID BOX

Filtered Tip, made in natural polypropylene, racked  
 DNase, RNase-free, human DNA, PCR inhibitors and Pyrogen free  
 STERILE, Autoclavable at 121°C

Universal filter tips are compatible with most popular brands ,  
 Such as: Eppendorf, Gilson, Socorex, HTL, Finnpiquette, Nichiryo, Clinipette brand etc

All of tips are produced in 100,000net clean room and under strict manufacturing processes  
 with premium materials, to assure the highest quality.



Product Cat#	Description	Color	Volume	Suitable	Packaging Specification
YPT0010-T-F-S	Box-packed , Filter Sterilized	Transparency	10UL	Eppendorf / Gilson	96pcs/Box, 50Box/Carton 4800pcs/Carton <b>47*27*28cm</b>
YPT0020-T-F-S	Box-packed , Filter Sterilized	Transparency	20UL	Eppendorf / Gilson	96pcs/Box, 50Box/Carton 4800pcs/Carton <b>48*27*34cm</b>
YPT0100-T-F-S	Box-packed , Filter Sterilized	Transparency	100UL	Eppendorf / Gilson	96pcs/Box, 50Box/Carton 4800pcs/Carton <b>48*27*34cm</b>
YPT0200-T-F-S	Box-packed , Filter Sterilized	Transparency	200UL	Eppendorf / Gilson	96pcs/Box, 50Box/Carton 4800pcs/Carton <b>48*27*34cm</b>
YPT1000-T-F-S	Box-packed , Filter Sterilized	Transparency	1000UL	Eppendorf / Gilson	96pcs/Box, 50Box/Carton 4800pcs/Carton <b>52*27*46cm</b>
YPT1250-T-F-S	Box-packed , Filter Sterilized	Transparency	1250UL	Eppendorf / Gilson	96pcs/Box, 50Box/Carton 4800pcs/Carton <b>52*27*57cm</b>

# 10-200ul Rack tips Packaging

96tips /rack(box)

packaging by box

96tips/box(rack)  
50boxes/carton;

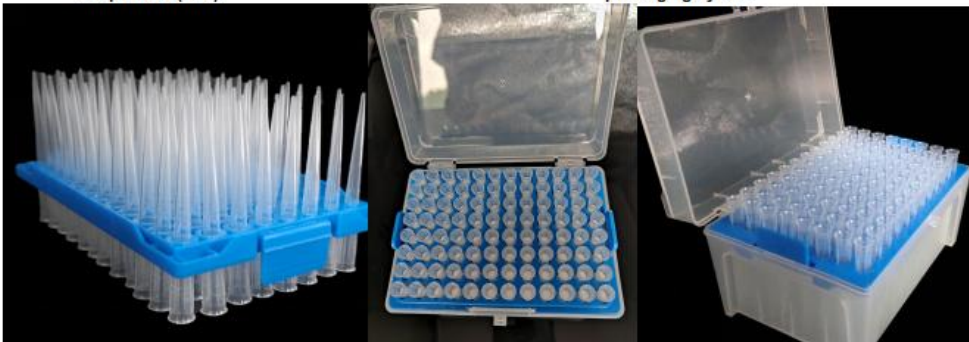

## 10UL Packaging:Transparent Box - Packed

96PCS/ Rack 50Boxes/ carton  
4800pcs/Carton  
Carton size47\*27\*28cm G.W:6.5KG/Carton  
G.W:6.5KG/Carton  
48Cartons /Pallets  
1.1\*1.1\*2.11m G.W:327kgs/PALLET 2.55CBM

## 10UL XL Packaging:Transparent Box - Packed

96PCS/ Rack 50Boxes/ carton  
4800pcs/Carton  
Carton size47\*25.7\*33.7cm G.W:6.5KG/Carton  
G.W:6.5KG/Carton  
48Cartons /Pallets  
1.1\*1.1\*2.11m G.W:327kgs/PALLET 2.55CBM

## 20-200ULPackaging:Transparent Box - Packed

96PCS/ Rack 50Boxes/ carton  
4800pcs/Carton  
Carton size 48\*27\*34cm G.W:6.5KG/Carton  
G.W:6.5KG/Carton  
48Cartons /Pallets  
1.1\*1.1\*2.19m G.W:327kgs/PALLET 2.65CBM



10boxes in a inner box(96\*10=960pcs tips in a inner box)

Sinner box /carton =50boxes in a carton(960\*5=4800pcs)

# 1000-1250ul Rack tips Packaging



**1000-1250ul Packaging:**Transparent Box - Packed  
96PCS/ Rack 50Boxes/ carton  
4800pcs/Carton  
Carton size 52\*27\*57cm  
G.W:12KG/Carton  
28Cartons /Pallets  
1.1\*1.1\*2.14m G.W:351kgs/PALLET 2.59CBM

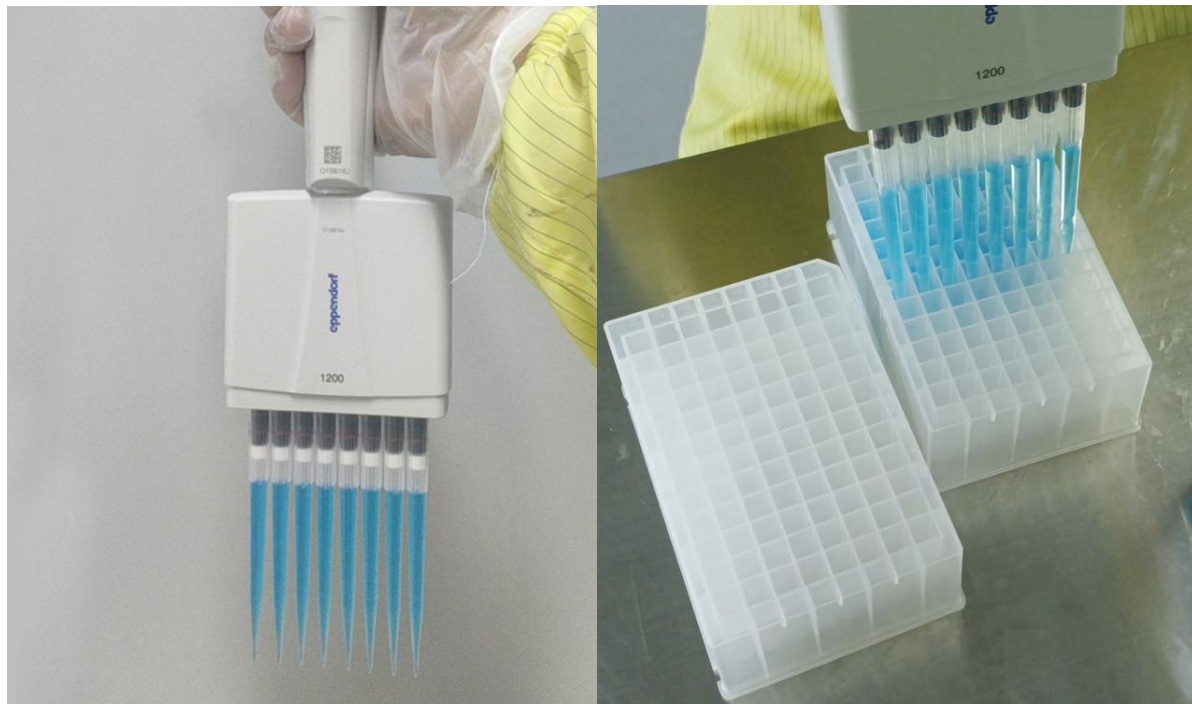

**Laboratory Consumables**  
**Compatible with Eppendorf ,Gilson ,Thermo Pipette**  
**Suitable products: Deep well plate ,PCR Tube .**



# Tips compatible with Pipette



User Manual



Quality Control Certificate



Accessory Supplied



Stand



Calibration Oil





Pipettes tips

Single Channel Adjustable Volume Pipette

Packaging:50Sets/Carton

Carton size: 45\*45\*32 CM

G.W:10kgs/Carton

Picture	Volume Range	Increment	Test Volume (μl)	Accuracy error		Precision error	
				%	μl	%	μl
	0.1-2.5μl	0.05μl	2.5	2.50%	0.0625	2.00%	0.05
			1.25	3.00%	0.0375	3.00%	0.0375
			0.25	12.00%	0.03	6.00%	0.015
	0.5-10μl	0.1μl	10	1.00%	0.1	0.80%	0.08
			5	1.50%	0.075	1.50%	0.075
			1	2.50%	0.025	1.50%	0.015
	2-20μl	0.5μl	20	0.90%	0.18	0.40%	0.08
			10	1.20%	0.12	1.00%	0.1
	5-50μl	0.5μl	2	3.00%	0.06	2.00%	0.04
			50	0.60%	0.3	0.30%	0.15
	10-100μl	1μl	25	0.90%	0.225	0.60%	0.15
			5	2.00%	0.1	2.00%	0.1
100			0.80%	0.8	0.15%	0.15	
20-200μl	1μl	50	1.00%	0.5	0.40%	0.2	
		10	3.00%	0.3	1.50%	0.15	
		200	0.60%	1.2	0.15%	0.3	
50-200μl	1μl	100	0.80%	0.8	0.30%	0.3	
		20	3.00%	0.6	1.00%	0.2	
		200	0.60%	1.2	0.15%	0.3	
100-1000 μl	5μl	100	0.80%	0.8	0.30%	0.3	
		50	1.00%	0.5	0.40%	0.2	
		1000	0.60%	6	0.20%	2	
200-1000 μl	5μl	500	0.70%	3.5	0.25%	1.25	
		100	2.00%	2	0.70%	0.7	
		1000	0.60%	6	0.20%	2	
1000-5000 μl	50μl	500	0.70%	3.5	0.25%	1.25	
		200	0.90%	1.8	0.30%	0.6	
		5000	0.50%	25	0.15%	7.5	
2-10ml	0.1ml	2500	0.60%	15	0.30%	7.5	
		1000	0.70%	7	0.30%	3	
		10ml	0.60%	60	0.20%	20	
	2-10ml	5ml	1.20%	60	0.30%	15	
		2ml	3.00%	60	0.60%	12	

# Micro Single Channel Adjustable Volume Pipette



## Features for TopPette

- Lightweight, ergonomic, low force design
- Digital display clearly reads volume setting
- The pipettes cover volume range of 0.1µl to 10ml
- Easy to calibrate and maintain with tool supplied
- Design helps avoid repetitive strain injuries
- Calibrated in accordance with ISO8655. Each pipette supplied with individual test certificate
- The low part is available for autoclaving

Picture	Volume Range	Increment	Test Volume (µl)	Accuracy error		Precision error	
				%	µl	%	µl
	0.1-2.5µl	0.05µl	2.5	2.50%	0.0625	2.00%	0.05
			1.25	3.00%	0.0375	3.00%	0.0375
			0.25	12.00%	0.03	6.00%	0.015
	0.5-10µl	0.1µl	10	1.00%	0.1	0.80%	0.08
			5	1.50%	0.075	1.50%	0.075
			1	2.50%	0.025	1.50%	0.015
	2-20µl	0.5µl	20	0.90%	0.18	0.40%	0.08
			10	1.20%	0.12	1.00%	0.1
	5-50µl	0.5µl	2	3.00%	0.06	2.00%	0.04
			50	0.60%	0.3	0.30%	0.15
			25	0.90%	0.225	0.60%	0.15
	10-100µl	1µl	5	2.00%	0.1	2.00%	0.1
100			0.80%	0.8	0.15%	0.15	
50			1.00%	0.5	0.40%	0.2	
20-200µl	1µl	10	3.00%	0.3	1.50%	0.15	
		200	0.60%	1.2	0.15%	0.3	
		100	0.80%	0.8	0.30%	0.3	
50-200µl	1µl	20	3.00%	0.6	1.00%	0.2	
		200	0.60%	1.2	0.15%	0.3	
		100	0.80%	0.8	0.30%	0.3	
100-1000 µl	5µl	50	1.00%	0.5	0.40%	0.2	
		1000	0.60%	6	0.20%	2	
		500	0.70%	3.5	0.25%	1.25	
200-1000 µl	5µl	100	2.00%	2	0.70%	0.7	
		1000	0.60%	6	0.20%	2	
		500	0.70%	3.5	0.25%	1.25	
1000-5000 µl	50µl	200	0.90%	1.8	0.30%	0.6	
		5000	0.50%	25	0.15%	7.5	
		2500	0.60%	15	0.30%	7.5	
2-10ml	0.1ml	1000	0.70%	7	0.30%	3	
		10ml	0.60%	60	0.20%	20	
		5ml	1.20%	60	0.30%	15	
			2ml	3.00%	60	0.60%	12







User Manual



Quality Control Certificate



Accessory Supplied



Stand



Calibration Oil





Pipettes tips

Single Channel Adjustable Volume Pipette

Packaging:50Sets/Carton

Carton size: 45\*45\*32 CM

G.W:10kgs/Carton

Picture	Volume Range	Increment	Test Volume (μl)	Accuracy error		Precision error	
				%	μl	%	μl
	0.1-2.5μl	0.05μl	2.5	2.50%	0.0625	2.00%	0.05
			1.25	3.00%	0.0375	3.00%	0.0375
			0.25	12.00%	0.03	6.00%	0.015
	0.5-10μl	0.1μl	10	1.00%	0.1	0.80%	0.08
			5	1.50%	0.075	1.50%	0.075
			1	2.50%	0.025	1.50%	0.015
	2-20μl	0.5μl	20	0.90%	0.18	0.40%	0.08
			10	1.20%	0.12	1.00%	0.1
	5-50μl	0.5μl	2	3.00%	0.06	2.00%	0.04
			50	0.60%	0.3	0.30%	0.15
	10-100μl	1μl	25	0.90%	0.225	0.60%	0.15
			5	2.00%	0.1	2.00%	0.1
100			0.80%	0.8	0.15%	0.15	
20-200μl	1μl	50	1.00%	0.5	0.40%	0.2	
		10	3.00%	0.3	1.50%	0.15	
		200	0.60%	1.2	0.15%	0.3	
50-200μl	1μl	100	0.80%	0.8	0.30%	0.3	
		20	3.00%	0.6	1.00%	0.2	
		200	0.60%	1.2	0.15%	0.3	
100-1000 μl	5μl	100	0.80%	0.8	0.30%	0.3	
		50	1.00%	0.5	0.40%	0.2	
		1000	0.60%	6	0.20%	2	
200-1000 μl	5μl	500	0.70%	3.5	0.25%	1.25	
		100	2.00%	2	0.70%	0.7	
		1000	0.60%	6	0.20%	2	
1000-5000 μl	50μl	500	0.70%	3.5	0.25%	1.25	
		1000	0.90%	1.8	0.30%	0.6	
		5000	0.50%	25	0.15%	7.5	
2-10ml	0.1ml	2500	0.60%	15	0.30%	7.5	
		1000	0.70%	7	0.30%	3	
		10ml	0.60%	60	0.20%	20	
	2-10ml	5ml	1.20%	60	0.30%	15	
		2ml	3.00%	60	0.60%	12	

# Manual Multi Channel Pipette Adjustable Dropper Pipette



8 channel pipettes



12 channel pipettes

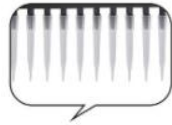

Features for multi-channel top pipettes

- . 8 and 12 channel pipettes are available for standard 96-well plate
- . Dispensing head rotates for optimum pipetting convenience
- . Individual piston and tip cone assemblies allow easy repair and maintenance
- . Compound material tip cone design allows visual seal verification
- . Can be used with universal style pipette tips

Test Volume(ul)	Accuracy Error		Precision Error	
	%	ul	%	ul
10	1.5%	0.15	1.5%	0.15
5	2.5%	0.125	2.5%	0.125
2	4.0%	0.04	4.0%	0.04
5 - 50	50	1.0%	0.5	0.5%
	25	1.5%	0.375	1.0%
	5	3.0%	0.15	2.0%
50 - 300	300	0.7%	2.1	0.25%
	150	1.0%	1.5	0.5%
	50	1.5%	0.75	0.8%

# 12 Multi Channel Pipette Instructions



# Manual Multi Channel Pipette Adjustable Dropper Pipette



## Description

\*The range of pipette cover a volume range from 0.5 $\mu$ L to 300 $\mu$ L

\* The adjustable volume pipette delivers high quality with excellent value for money.

The range is manufactured from the latest materials ensuring a lightweight and durable pipette ,which will give many reliable service.

Volume Range(ul)	Increment(ul)	Test Volume(ul)	Accuracy Error		Precision Error	
			%	ul	%	ul
0.5 - 10	0.1	10	1.5%	0.15	1.5%	0.15
		5	2.5%	0.125	2.5%	0.125
		2	4.0%	0.04	4.0%	0.04
5 - 50	0.5	50	1.0%	0.5	0.5%	0.25
		25	1.5%	0.375	1.0%	0.25
		5	3.0%	0.15	2.0%	0.1
50 - 300	5	300	0.7%	2.1	0.25%	0.75
		150	1.0%	1.5	0.5%	0.75
		50	1.5%	0.75	0.8%	0.4

# Accessories 8 Channel & 12 Channel Pipette



Multi Channel Adjustable Volume Pipette

Packaging: 50 Sets / Carton

Carton size: 45\*45\*32 CM

G.W: 12kgs / Carton



# Out going with pallet



50PCS/ carton Carton size :45\*45\*32 CM  
G.W:12kgs/Cs



Out going Packaging with pallet  
24Cartons/Pallet 1200PCS/Pallet  
G.W 303kgs/Pallet 2.51CBM Pallet size:1.1\*1.1\*2.07M